

## Operating instructions and Spare parts

**GLW 222 AC/DC**  
Portable Inverter



Carl Cloos Schweisstechnik GmbH

Industriestrasse

35708 Haiger

Germany

Telephone: (0 27 73) 85-0

Telefax: (0 27 73) 85-275

E-Mail: [info@cloos.de](mailto:info@cloos.de)

Internet: <http://www.cloos.de>

RW - FP - Rev.0

release date: 10.12.15

Keep for further use.

CARL CLOOS Schweißtechnik GmbH  
Industriestraße  
35708 Haiger  
Tel.(+49) 2773/85-0  
Fax.(+49) 2773/85-275  
mail: info@cloos.de  
www.cloos.de



Dokument: QIGLW222

Monat/Jahr: 10/12

**EG-Konformitätserklärung  
im Sinne der EG-Richtlinien 2006/95/EG (Niederspannung) und 2004/108/EG (EMV)**

Hiermit erklären wir, dass das nachfolgend aufgeführte Gerät in Übereinstimmung mit den EU-Richtlinien entwickelt, konstruiert und gefertigt sowie in den Verkehr gebracht wurde.

**Bezeichnung des Gerätes:** WIG Schweissgerät  
**Typbezeichnung:** QINEO GLW 222 AC/DC  
**Fabriknummer:** siehe Typenschild (Geräterückseite)

**Folgende EG-Richtlinien sind angewandt:**

- EG-Niederspannungsrichtlinie (2006/95/EG)
- EG-Richtlinie Elektromagnetische Verträglichkeit (2004/108/EG)
- EG-Richtlinie RoHS (2002/95/EG)

**Folgende harmonisierte Normen sind angewandt:**

- EN 60974-1 Lichtbogenschweißeinrichtungen  
Teil 1: Schweißstromquellen
- EN 60974-3 Lichtbogenschweißeinrichtungen  
Teil 3: Lichtbogenzünd- und stabilisierungseinrichtungen
- EN 60974-10 Lichtbogenschweißeinrichtungen  
Teil 10: Anforderungen an die elektromagnetische Verträglichkeit (EMV)

Wesentliche Umbauten oder Erweiterungen, die nicht durch den o. g. Hersteller oder durch seine befugten Vertreter durchgeführt wurden, führen zum Erlöschen dieser Konformitätserklärung.

Hersteller Unterschrift:  
Angaben zum Unterzeichner:

Dipl.-Kfm. Ralf Pulverich  
Geschäftsführer

<b>1</b>	<b>INTRODUCTION .....</b>	<b>4</b>	13.2	2T HF WELDING.....	24
<b>2</b>	<b>FRONT PANEL .....</b>	<b>4</b>	13.3	4T LIFT-ARC WELDING .....	24
<b>3</b>	<b>REAR PANEL .....</b>	<b>5</b>	13.4	4T HF WELDING.....	25
<b>4</b>	<b>INSTALLATION .....</b>	<b>5</b>	13.5	BI-LEVEL LIFT WELDING .....	25
4.1	CONNECTIONS TO THE ELECTRICAL MAINS NETWORK.....	5	13.6	BI-LEVEL HF WELDING .....	25
4.2	PREPARING FOR MMA WELDING.....	5	13.7	2T SPOT WELDING.....	25
4.3	PREPARING FOR TIG WELDING .....	6	13.8	2T SPOT HF WELDING.....	26
<b>5</b>	<b>USER INTERFACE .....</b>	<b>8</b>	13.9	PILOT ARC WELDING.....	26
<b>6</b>	<b>UNIT POWER-UP.....</b>	<b>9</b>	<b>14</b>	<b>TECHNICAL DATA.....</b>	<b>27</b>
<b>7</b>	<b>RESET (LOAD FACTORY SETTINGS).....</b>	<b>9</b>	<b>15</b>	<b>SPARE PARTS.....</b>	<b>28</b>
7.1	PARTIAL RESET .....	9	<b>16</b>	<b>ELECTRICAL DIAGRAM .....</b>	<b>30</b>
7.2	TOTAL RESET .....	10	16.1	GLW 222 AC/DC .....	30
<b>8</b>	<b>SET-UP (INITIAL SET-UP OF THE WELDING POWER SOURCE) .....</b>	<b>10</b>	16.2	TORCH CONNECTOR .....	31
8.1	TORCH LOADING.....	12	16.3	REMOTE CONTROLLER CONNECTOR .....	31
<b>9</b>	<b>ALARMS MANAGEMENT .....</b>	<b>12</b>			
	THERMAL ALARM! .....	12			
	COOLING DEVICE ALARM.....	12			
<b>10</b>	<b>WELDING PARAMETERS.....</b>	<b>13</b>			
	Welding current.....	13			
	Max welding current.....	13			
	Hot-start .....	13			
	Arc-force.....	13			
	VRD.....	13			
	Long arc voltage .....	13			
	Remote control.....	13			
	Dynamic arc .....	13			
	Second current Bi-level.....	13			
	Base current.....	13			
	Peak time .....	14			
	Base time .....	14			
	Pulse frequency .....	14			
	Slope down .....	14			
	Final current .....	14			
	Post-gas.....	14			
	Pre-gas.....	14			
	Start current .....	14			
	Slope up.....	14			
	Spot TIG time.....	14			
	HF arc start .....	14			
	Minimum pedal current .....	14			
	Q-start .....	14			
	Multi-tack.....	14			
	AC wave in mix AC-DC.....	14			
	Extra fusion .....	14			
	AC frequency .....	15			
	AC balance .....	15			
	Electrode diameter.....	15			
10.1	PARAMETERS ACTIVATION .....	16			
<b>11</b>	<b>WELDING SETTINGS.....</b>	<b>18</b>			
11.1	ELECTRODE WELDING (MMA) .....	18			
11.1.1	MMA PARAMETERS SETTING (1ST LEVEL).....	18			
11.1.2	MMA PARAMETERS SETTING (2ND LEVEL) .....	18			
11.1.3	MMA SPECIAL FUNCTIONS .....	18			
11.2	DC TIG WELDING.....	19			
11.2.1	DC TIG PARAMETERS SETTING (1ST LEVEL).....	19			
11.2.2	DC TIG PARAMETERS SETTING (2ND LEVEL) .....	19			
11.2.3	DC TIG SPECIAL FUNCTIONS MENU .....	20			
11.3	AC TIG WELDING .....	21			
11.3.1	AC TIG PARAMETERS SETTING (1ST LEVEL).....	21			
11.3.2	AC TIG PARAMETERS SETTING (2ND LEVEL).....	21			
11.3.3	AC TIG SPECIAL FUNCTIONS MENU .....	22			
<b>12</b>	<b>JOBS MANAGEMENT.....</b>	<b>23</b>			
12.1	SAVING A JOB.....	23			
12.2	LOADING A USER JOB OF FACTORY SET JOB.....	23			
12.3	DELETING A JOB .....	23			
<b>13</b>	<b>TORCH TRIGGER MODES .....</b>	<b>24</b>			
13.1	2T LIFT-ARC WELDING.....	24			



### 3 REAR PANEL

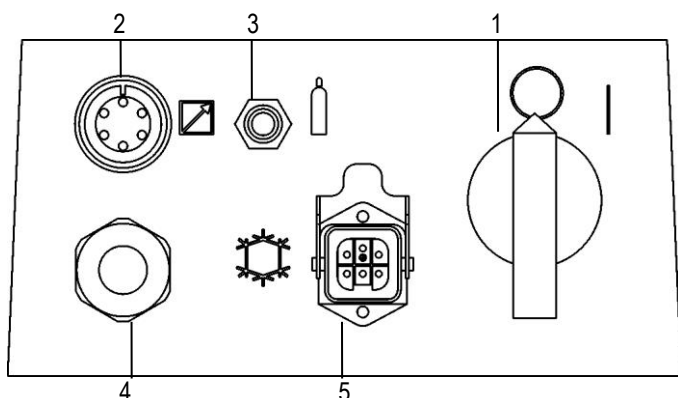

- 1: Welding power source ON/OFF switch.
- 2: Remote controller connector.
- 3: Connector for gas feed hose:  
cylinder → power source
- 4: Power cable.

Total length (including internal part)	2,5 m
Number and cross section of wires	3 x 2,5 mm <sup>2</sup>
Type of plug supplied	Schuko

- 5: Cooler power feeding connector.

Voltage	230 V~
Current output	1.35 A
IP protection rating	IP20 (cap open) IP66 (cap closed)

**WARNING!**  
**High voltage!**

If the socket is not connected to any devices always close the cap:  
presence of hazardous voltage levels!

### 4 INSTALLATION

**WARNING!**  
**Lifting and positioning**

Read the warnings highlighted by the following symbols in the "General prescriptions for use".

#### 4.1 CONNECTIONS TO THE ELECTRICAL MAINS NETWORK

The characteristics of the mains power supply to which the equipment shall be connected are given in the section entitled "technical data" on page 27.

The machine can be connected to motorgenerators provided their voltage is stabilised.

Connect/disconnect the various devices with the machine switched off.

#### 4.2 PREPARING FOR MMA WELDING

1. Set the welding power source ON/OFF switch to "O" (unit de-energized).
2. Plug the power cable plug into a mains socket outlet.

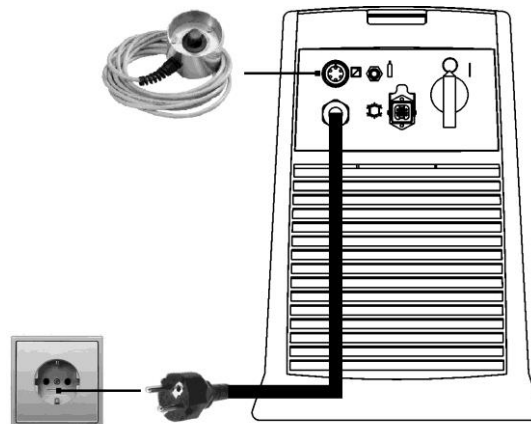

3. Choose the electrode based on the type of material and thickness of the workpiece to be welded.
4. Insert the electrode in the electrode holder.
5. Connect the electrode holder clamp plug to the following welding socket: Positive pole welding socket.
6. Connect the earth clamp plug to the following welding socket: Negative pole welding socket.
7. Connect the earth clamp to the workpiece being processed.

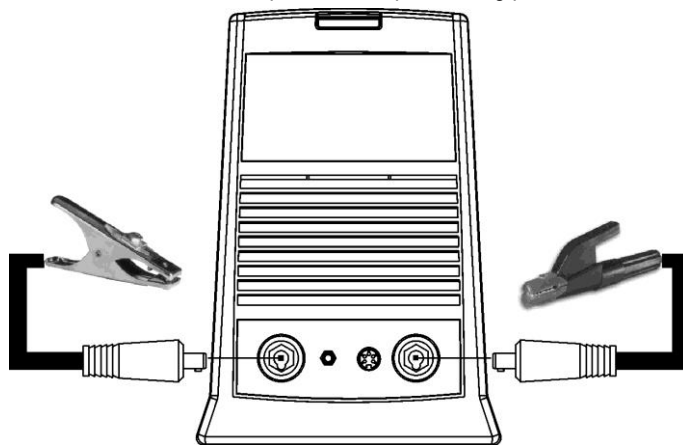

**WARNING!**  
**Electric shock hazard!**

Read the warnings highlighted by the following symbols in the "General prescriptions for use".

8. Set the welding power source ON/OFF switch to "I" (unit powered).
  9. Select the following welding mode on the user interface: MMA
  10. Set the required welding parameter values on the user interface.
- ⓘ When the remote controller [RC] is connected and the relative locking screw is tightened, welding current can be adjusted using the remote controller.

The system is ready to start welding.

### 4.3 PREPARING FOR TIG WELDING

#### Installation with cooling unit

1. Set the welding power source ON/OFF switch to "O" (unit de-energized).
2. Remove the screws from the power source cabinet.

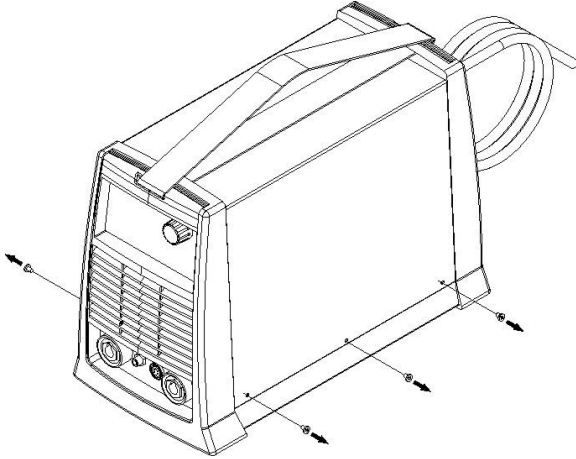

3. Loosen the screws of the upper brackets of the cooler and open out the brackets slightly.

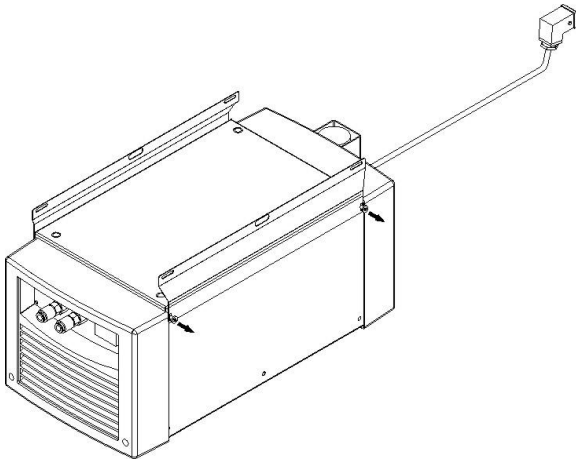

4. Place the power source on top of the cooler.
5. Secure the cooler brackets to the power source using the previously removed screws.

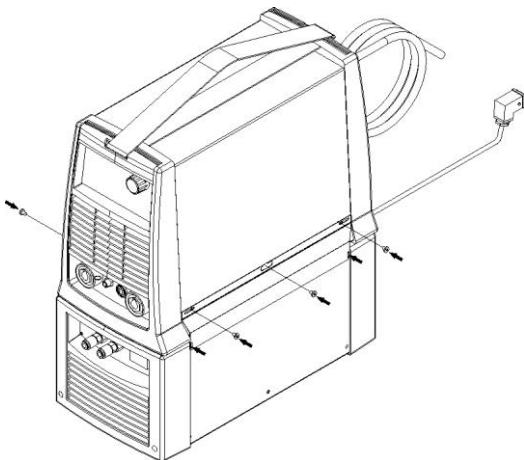

6. Connect the plug of the cooler power cable to the cooler power socket on the rear panel of the welding power source.
7. Set the cooler ON/OFF switch to "I" (unit powered).
8. Plug the power cable plug into a mains socket outlet.

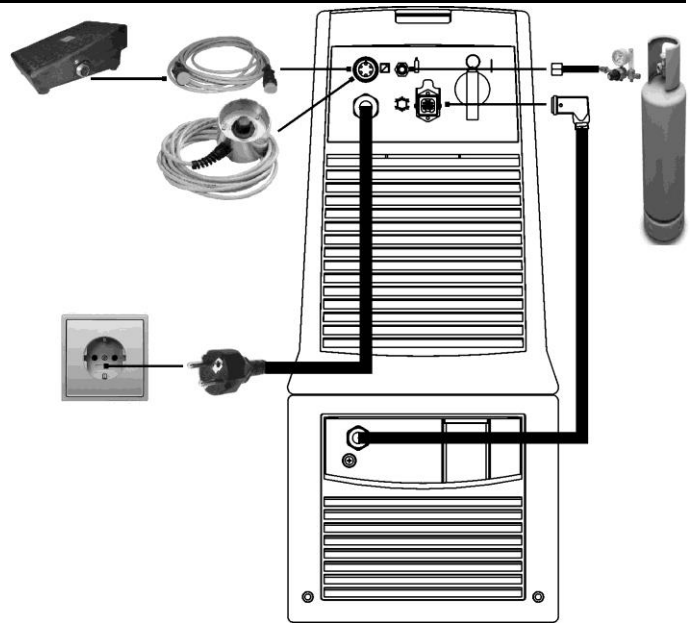

9. Connect the gas hose from the welding gas cylinder to the rear gas socket.
10. Open the cylinder gas valve.

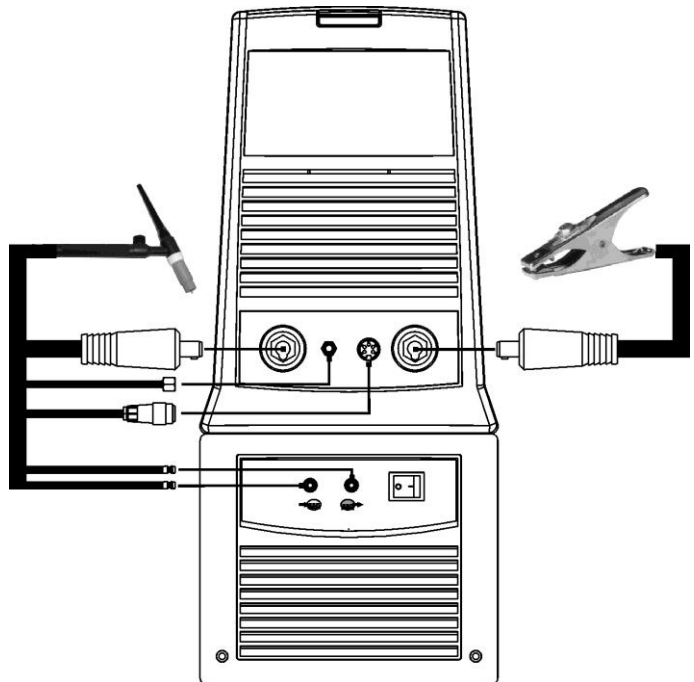

11. Connect the gas hose from the welding torch to the front gas socket.
12. Connect the torch plug to the welding socket on the basis of the polarity required by the type of electrode in question.
13. Choose the electrode based on the type of material and thickness of the workpiece to be welded.
14. Insert the electrode in the TIG torch.
15. Connect the plug of the ground clamp to the welding socket on the basis of the polarity required.
16. Connect the earth clamp to the workpiece being processed.
17. Set the welding power source ON/OFF switch to "I" (unit powered).
18. Select the following welding mode on the user interface: TIG DC / TIG AC
19. Press the torch trigger with the torch well clear of any metal parts. This serves to open the gas solenoid valve without striking the

---

welding arc.

20. Use the flow control valve to adjust the flow of gas as required while the gas is flowing out.
  21. Set the required welding parameter values on the user interface.
- ⓘ When the remote control pedal is connected and the relative locking screw is tightened the welding current will vary in relation to the pressure exerted on the pedal.







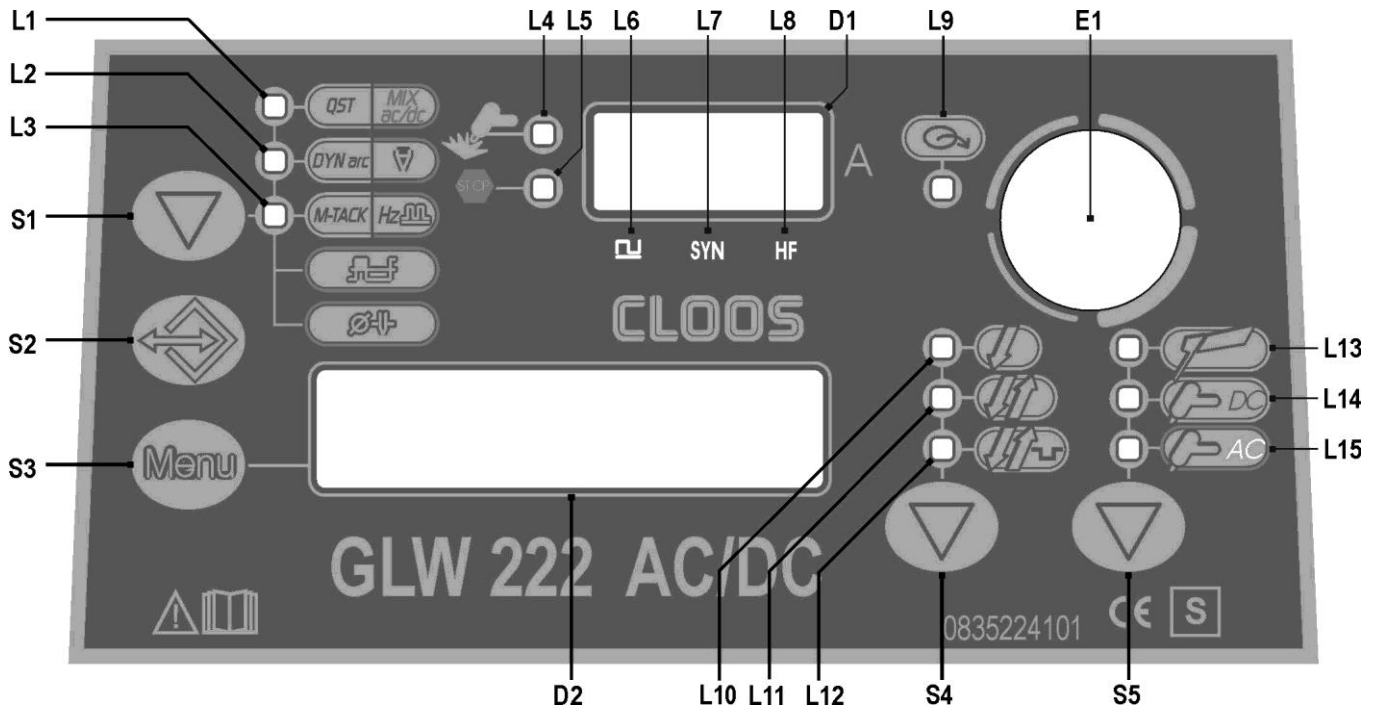

The system is ready to start welding.



## 5 USER INTERFACE



CODE	SYMBOL	DESCRIPTION
L1		<b>DC TIG mode:</b> Illumination shows that the following function has been activated: Q-START
L2		<b>AC TIG mode:</b> Illumination shows that the following function has been activated: AC WAVE IN MIX AC-DC
L3		<b>DC TIG mode:</b> Illumination shows that the following function has been activated: DYNAIC ARC
L4		<b>AC TIG mode:</b> Illumination shows that the following function has been activated: FUSIONE EXTRA
L5		<b>DC TIG mode:</b> Illumination shows that the following function has been activated: MULTI TACK
L6		<b>AC TIG mode:</b> When this LED illuminates the following parameter can be set: AC FREQUENCY
L7		<b>AC TIG mode:</b> When this LED illuminates the following parameter can be set: AC TIG BALANCE
L8		<b>AC TIG mode:</b> When this LED illuminates the following parameter can be set: ELECTRODE DIAMETER
L9		This LED illuminates to confirm the presence of power on the output sockets.
L10		This LED illuminates to show an anomaly in the operating conditions. See "ALARMS MANAGEMENT" (§ 9 page 12).
L11		This LED illuminates to show that the following welding mode is selected: TIG PULSED
L12		<b>DC TIG mode:</b> When this LED illuminates the following parameter can be set: TIG SYNERGIC PULSE When this is on, it means that the synergic mode is active and that the operator can set just the welding current while the other parameters are automatically regulated by the machine. The synergy is optimised by angle welding.
L13		Illumination shows that the following function has been activated: High frequency arc strike (HF)
L14		This LED indicates that the current reference setting is imposed by the remote controller.
L15		Illumination shows that the following function has been activated: 2 times procedure § 13.1 page 24 / § 13.2 page 24
D1		A flashing signal means the following function is activated: 2 times procedure § 13.7 page 26 / § 13.8 page 26
		Illumination shows that the following function has been activated: 4 times procedure § 13.3 page 24 / § 13.4 page 25
		Illumination shows that the following function has been activated: 4 times Bi-level procedure § 13.5 page 25 / § 13.6 page 25
		This LED illuminates to show that the following welding mode is selected: MMA
		This LED illuminates to show that the following welding mode is selected: TIG CONTINUOUS
		This LED illuminates to show that the following welding mode is selected: AC TIG
		<b>Parameters/functions setting:</b> The displays show the value of the following parameter: WELDING CURRENT
		<b>Welding:</b> The display shows the effective amperes value during welding.
		<b>HOLD function:</b> The display shows the latest measured current value.

D2		<b>Data setting:</b> The display shows the various welding menus relative to the selected processes. The display shows the selected parameter.
S1		<b>AC TIG mode:</b> Press the button to select the parameter to be set. Possible choices: Extra Fusion AC Frequency AC Balance
S2		Press the button once to open the JOB upload menu. Hold down the button for 3 seconds to gain access to the JOB save/delete menu.
S3		Press the button once to select the parameters of the first level menu. Hold down the button for 3 seconds to gain access to the second level menu. Hold down the button at the time of power-on to gain access to the SETUP menu.
S4		This button selects the torch trigger procedure.  § 13 page 24
S5		This button selects the welding mode.
E1		<b>Parameters/functions setting:</b> The encoder provides the facility to alter the selected parameter. <b>Welding:</b> The encoder allows the welding current to be modified.

## 6 UNIT POWER-UP

Set the welding power source ON/OFF switch to “1” to switch on the unit.

-  **221AC/DC**  
**Fx.x** The message appears on the following displays: D2  
x.x= software version

### First power-up or power-ups following a RESET procedure

-  The welding power source sets up for welding with the factory presets.

### Subsequent power-ups

-  The welding power source sets up for welding in the latest stable welding configuration that was active at the time of power-off.

## 7 RESET (LOAD FACTORY SETTINGS)

The reset procedure involves complete restoration of the default values, parameters and memory settings set in the factory.

The reset procedure is useful in the following cases:



- Too many changes made to the welding parameters so user finds it difficult to restore defaults.
- Unidentified software problems that prevent the welding power source from functioning correctly.

### 7.1 PARTIAL RESET

The reset procedure involves restoration of the parameter values and settings, except the following settings:

- settings of the SETUP menu
- saved JOBS
- set language

Set the welding power source ON/OFF switch to “0” to switch the unit off.



- S3  S5  Hold down both buttons simultaneously.

Set the welding power source ON/OFF switch to “1” to switch on the unit.



-  **RECALL PARTIAL SETUP ?** The message appears on the following displays: D2



#### Exit without confirmation

-  Press any button (except S2).  
 This action will automatically close the menu.



#### Exit with confirmation

- S3  Press the button.  
 This action will automatically close the menu.  
Wait for the memory clear procedure to terminate.

## 7.2 TOTAL RESET

The reset procedure involves complete restoration of the default values, parameters and memory settings set in the factory. All memory locations will be reset and hence all your personal welding settings will be lost!

Set the welding power source ON/OFF switch to "O" to switch the unit off.

S3  S5  Hold down both buttons simultaneously.



Set the welding power source ON/OFF switch to "I" to switch on the unit.

 **RECALL PARTIAL SETUP ?** The message appears on the following displays: D2

E1  Select the following setting with the encoder:

**RECALL FACTORY SETUP ?**

### Exit without confirmation

 Press any button (except S2).

 This action will automatically close the menu.

### Exit with confirmation

S3  Press the button.

 **MEMORY RESETTING NOW.....** The message appears on the following displays: D2

 This action will automatically close the menu.

Wait for the memory clear procedure to terminate.

## 8 SET-UP (INITIAL SET-UP OF THE WELDING POWER SOURCE)

Set the welding power source ON/OFF switch to "O" to switch the unit off.

S3  Hold down the button.





Set the welding power source ON/OFF switch to "I" to switch on the unit.

**SET UP** The message appears for a few seconds on the following displays: D2

 **SELECT LANGUAGE:** The message appears on the following displays: D2

S3  Use this button to scroll the settings to edit.

E1  Using the encoder, edit the value of the selected setting.

 Press any key (except S3) to save the setting and quit the menu.

**Tab. 1 - Setup settings**

SETTING	MIN	DEFAULT	MAX	
SELECT LANGUAGE:				ITALIANO ENGLISH FRANÇAIS DEUTSCH ESPAÑOL DUTCH PORTUGUES SUOMI CESKY POLSKI DANSK
COOLER ACTIVATION	OFF	AUT	ON	
START CURRENT	%	A	A	*1
FINAL CURRENT	%	A	A	*1
CURRENT HF	20 A	SYN	220 A	
HF TIME	0.5 s	2.0 s	3.0 s	
KIND OF PULSE	SLOW (*2)	SLOW	FAST (*3)	
PILOT ARC	OFF	OFF	ON	

\*1: The value of this parameter can be set as a percentage of the welding current or as an absolute value expressed in Amperes.

\*2: This setting enables slow pulsed mode.

\*3: This setting enables fast pulsed mode.

---

**Cooler activation**

- ON= The cooler is always running when the power source is switched on. This mode is preferable for heavy duty and automatic welding procedures.
- OFF= The cooler is always disabled because an air-cooled torch is in use.
- AUT= When the unit is switched on the cooler is switched on for 16 s. During welding procedures the cooler runs constantly. When welding is terminated the cooler continues to run for 90 s + a number of seconds equivalent to the average current value shown using the HOLD function.

**Current HF**

This parameter establishes the current value during HF discharge. The value of this parameter can be set as an absolute value or in SYN.

With SYN setting the HF current value is calculated automatically on the basis of the preset welding current value.

Consequences of a higher value:

- Arc striking is facilitated, even on very dirty workpieces.
- Risk of piercing excessively thin gauge workpieces.

**Pilot arc**

The function enables the output of a low current between the 1st and 2nd times of the torch trigger to shield the mask in advance and avoid the risk of blinding flashback caused by the welding current.

## 8.1 TORCH LOADING



### WARNING!

Make sure the torch in use is correctly sized in relation to the welding current required and for the available and selected cooling type. This prevents the risk of burns to which the operator is potentially exposed, potential faults, and irreversible damage to the torch and the system.



If a torch is installed or replaced while the unit is running, the circuit of the newly installed must be filled with coolant to avoid the risk of damage to the torch in the case of high voltage arc strikes without any liquid in the circuit.

### Power-up with operation of the cooler set to "ON" or "AUT" mode



A check is performed automatically of the presence of liquid in the cooling circuit and the cooler is switched on for 15 seconds.

If the coolant circuit is full, the power source sets up in the most recent stable welding configuration.

If the coolant circuit is not full, all functions are inhibited and there will be no output power present.

-  **COOLING DEVICE ALARM**      The message appears on the following displays: D2
  - (any)  Press the button or torch trigger to repeat the checking procedure for an additional 15 seconds.
  - If the problem persists rectify the cause of the alarm.

### Power-up with operation of the cooler set to "OFF"



-  Operation of the cooler and the cooler alarm are disabled.
-  Welding is performed without liquid cooling of the torch.

### Torch change-over with operation of the cooler set to "ON"

Press and release the torch trigger.

-  This serves to start the cooler for 15 seconds to fill the torch cooling circuit.

## 9 ALARMS MANAGEMENT

-  This LED illuminates if an incorrect operating condition occurs.
-  An alarm message appears on the following display: D2

**Tab. 2 - Alarm messages**

MESSAGE	MEANING	EVENT	CHECKS
THERMAL ALARM!	<p><b>Overheating alarm</b> Indicates tripping of the welding power source thermal protection. Leave the unit running so that the overheated components cool as rapidly as possible. When the unit has cooled, the welding power source will reset automatically.</p>	<p>All functions disabled. Exceptions: - cooling fan. - cooler (if switched on).</p>	<ul style="list-style-type: none"> <li>- Make sure that the power required by the welding process is lower than the maximum rated power output.</li> <li>- Check that the operating conditions are in compliance with the welding power source data plate specifications.</li> <li>- Check for the presence of adequate air circulation around the welding power source.</li> </ul>
COOLING DEVICE ALARM	<p><b>Cooler alarm</b> Indicates insufficient pressure in the torch liquid cooling circuit.</p>	<p>All functions disabled. Exceptions: - cooling fan. The alarm message persists on the display until the first operation is performed on the user interface. <b>Cooler ON:</b> the alarm is signalled as long as the unit alarm is active and the cooler presence signal persists. <b>Cooler OFF:</b> the alarm is never signalled, irrespective of the circumstances. <b>Cooler AUT:</b> the alarm is signalled at the times in which the unit is running; the alarm signal occurs as long as the unit presence signal persists.</p>	<ul style="list-style-type: none"> <li>- Check that the connection to the cooler is correct.</li> <li>- Check that the O/I switch is set to I and that it illuminates when the pump is running.</li> <li>- Check that the cooler is filled with coolant.</li> <li>- Check that the cooling circuit is liquid tight, notably the torch hoses and the internal connections of the cooler.</li> </ul>

## 10 WELDING PARAMETERS

For a better understanding of the parameter functions described in the table, refer to the following diagram.

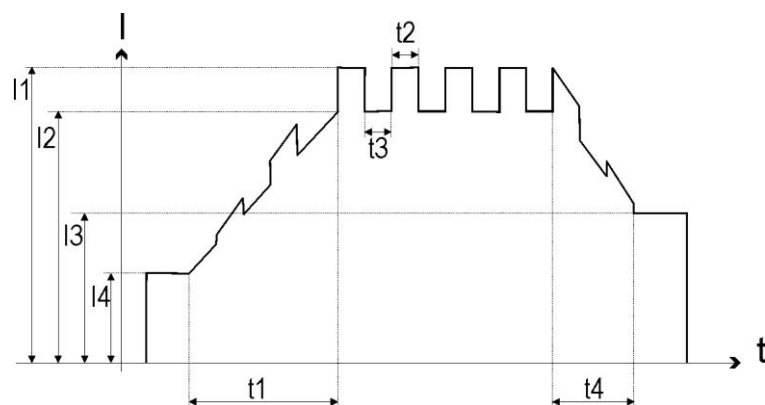

(I1) TIG WELDING CURRENT

(I2) BASE CURRENT

(I3) FINAL CURRENT

(I4) STARTING CURRENT

(t1) UP SLOPE TIME

(t2) PEAK TIME

(t3) BASE TIME

(t4) DOWN SLOPE TIME

 $(1/t2+t3)$  PULSED CURRENT FREQUENCY

### Welding current

Output current value during welding.

### Max welding current

Maximum output current value that can be achieved with remote controller external reference.

### Hot-start

This parameter aids electrode melting at the time of arc striking.

Consequences of a higher value:

- Easier arc strike.
- Increased spatter at welding start.
- Increase of strike area.

Consequences of a lower value:

- More difficult arc strike.
- Less spatter at welding start.
- Smaller strike area.

### Arc-force

This parameter helps to avoid electrode sticking during welding.

Consequences of a higher value:

- Fluidity during welding.
- Welding arc stability.
- Greater electrode fusion in workpiece.
- More welding spatter.

Consequences of a lower value:

- The arc is extinguished more easily.
- Less welding spatter.

### VRD

This parameter reduces the potential across the welding sockets when welding is not in progress.

The arc strike procedure is as follows:

- Touch the workpiece with the electrode tip.
- Raise the electrode.

Power is released for several seconds.

- Touch the workpiece with the electrode tip.

The welding arc will strike.

### Long arc voltage

This parameter inhibits power output when the potential between electrode and workpiece exceeds the preset threshold level.

Consequences of a higher value:

- The welding arc persists even with a significant distance between the electrode and the workpiece.

Consequences of a lower value:

- Faster exit from weld.

### Remote control

This parameter enables the unit to receive the current reference signal from a remote control.

### Dynamic arc

Welding power remains constant even when the distance between electrode and workpiece changes.

Consequences of a higher value:

- The welding arc concentration remains unchanged.
- Prevents electrode sticking.
- Thin workpieces may become deformed more easily.

### Second current Bi-level

With a rapid press and release (less than 0.5 seconds) of the torch trigger during welding, the output current value switches to the value set by means of the "bi-level second current" parameter.

In DC TIG welding, the parameter is useful when welding different gauge workpieces during the same pass; when moving between different gauges the output current can be changed simply by pressing the torch trigger.

In AC TIG welding the parameter is useful to change the heat output during welding; when the workpiece heats up to the point at which there is a risk of deformation, the current value (= heat) can be reduced simply by pressing the torch trigger.

### Base current

Pulsed wave minimum current.

Consequences of a higher value:

- Faster creation of weld pool.
- Increase of heat-affected zone.

**Peak time**

Time for which the current pulse is at the maximum value.

Consequences of a higher value:

- Greater weld penetration.
- Facility to make deeper cuts.

Consequences of a lower value:

- Reduction of heat-affected zone.
- Difficult to create a weld pool.

**Base time**

Time during which current output is at the base value.

Consequences of a higher value:

- The filler material is spread more evenly.
- Increase of heat-affected zone.

**Pulse frequency**

Consequences of a higher value:

- Slower melt speed.
- Reduction of heat-affected zone.

**Slope down**

Time during which the current changes from the welding value to the end value by means of a slope.

**Final current**

During electrode welding the parameter makes it possible to obtain a uniform deposit of filler material from the start to the end of the welding process, closing the deposition crater with a current such as to deposit a final droplet of filler material.

By keeping the torch trigger pressed during the 3rd time, the crater filler current is maintained thereby ensuring optimal crater filling, until the POST GAS time is started by releasing the torch trigger (4Th time).

**Post-gas**

Time of post gas delivery when the welding arc is extinguished.

Consequences of a higher value:

- More effective pickling (improved appearance of workpiece at the end of the welding pass).
- Higher gas consumption.

Consequences of a lower value:

- Lower gas consumption.
- Oxidation of electrode tip (more difficult arc strike).

**Pre-gas**

Time of gas delivery before the arc strike.

Consequences of a higher value:

- This parameter allows a shielded environment to be created, thereby eliminating contaminants at the start of the welding pass.

**Start current**

Unit current output value immediately after the arc strike.

**Slope up**

Time during which the current changes from the starting value to the welding value by means of a slope.

**Spot TIG time**

When the torch trigger is pressed the welding arc persists for the time set in the parameter.

Press the torch trigger again to resume the welding process.

The arc strike procedure is as follows:

Positioning of the torch with the electrode on the workpiece.

Press the torch trigger and keep it pressed.

Lift the torch slightly.

As soon as the electrode is lifted then the HF ignition starts.

The arc ignites for few hundredths of a second (time can be set up).

The result of this is a very precise, not oxidized welding spot without any plastic deformation of the sheet.

**HF arc start**

This parameter enables the arc strike in the TIG welding procedure by means of a high frequency (HF) current discharge.

The parameter prevents the inclusion of impurities at the start of the weld pass.

This parameter can harm electronic boards when welding is performed on equipment that incorporates such devices.

**Minimum pedal current**

Minimum output current value with foot pedal controller external reference.

The current is set as a percentage with respect to the "maximum foot pedal current" parameter.

**Q-start**

This parameter allows the unit to start in synergic pulsed TIG mode for the preset time interval, before switching automatically to the welding procedure selected on the interface panel.

The parameter creates a weld pool faster with respect to the standard starting procedure.

This parameter is useful when spot welding thin gauge sheet.

**Multi-tack**

This parameter allows thin gauge sheet to be welded without deformation.

Consequences of a higher value:

- Welding of thinner gauge sheet without deformation.
- Less melting of material, slower welding process.

**AC wave in mix AC-DC**

This parameter serves to set the AC wave percentage with respect to the DC current output.

Consequences of a higher value:

- Greater weld penetration.
- Less deformation.
- Faster creation of the weld pool.
- Reduced cleanliness of the workpiece.
- Loss of arc.

**Extra fusion**

This parameter establishes the percentage of the positive current wave (pickling) that is subtracted and added to the negative current (fusion).

The following picture shows the positive wave interval  $\Delta I$  that, if subtracted and added to the negative wave, forms the new form of broken line wave.

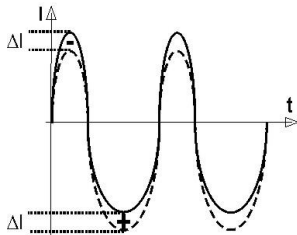

Consequences of a higher value:

- Tighter arc.
- Greater weld penetration.
- Reduced pickling.
- Loss of arc.
- Less deformation of the electrode.

**AC frequency**

The picture below shows the example where the wave on the second graph has a double frequency compared with the first.

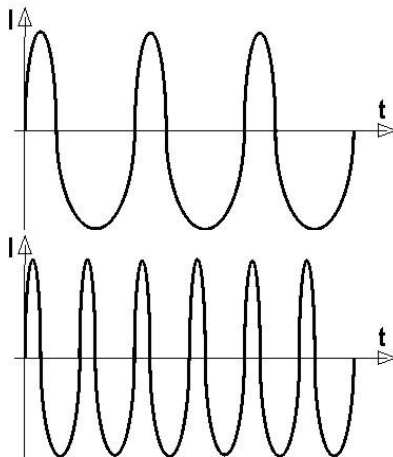

Consequences of a higher value:

- Arc concentration.
- Reduction of heat-affected zone.
- Reduction of heat-affected zone.
- Slower melt speed.

**AC balance**

This parameter establishes the positive wave vs. negative wave time ratio.

The following figure shows two graphs with different balance value: the first graph represents the curve of the current with a negative value balance (more penetration) in which it can be seen that there is a low percentage of positive wave compared with the negative.

In the second graph the current curve is shown with a positive value balance (more cleaning); in this case the percentage of the positive wave is greater than the negative one.

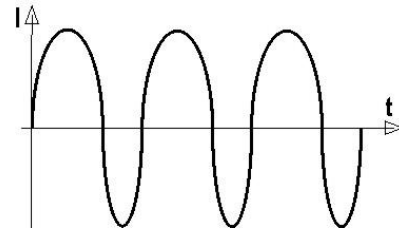
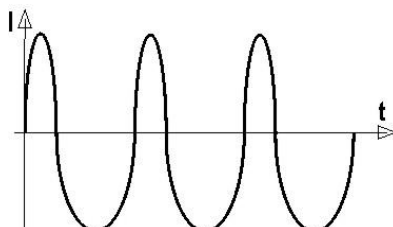

Consequences of a higher value:

- Greater weld penetration.
- Less cleanliness.

**Electrode diameter**

The parameter optimizes the AC TIG welding arc strike on the basis of the diameter of the chosen electrode.



**10.1 PARAMETERS ACTIVATION**

The welding parameters are available in accordance with the selected welding mode and procedure.  
Certain parameters are available only after other parameters or functions of the unit have been enabled or set.  
The table shows the settings required to enable each parameter.

✓: always available

1: Available with the user interface reference active

2: Available with "REMOTE CONTROL"= ON and remote controller connected

3: Available when "HF ARC START" parameter =ON

6: Available with "KIND OF PULSE"= FAST

4: Not available with "MULTI TACK" active



5: Available with "KIND OF PULSE"= SLOW

MENU ▼	MODE →	DC			DC <sub>SYN</sub>			AC			AC <sub>U</sub>				
		↓	↓ <sub>SPOT</sub>	↓ <sub>SPOT</sub>	↓	↓ <sub>SPOT</sub>	↓ <sub>SPOT</sub>	↓	↓ <sub>SPOT</sub>	↓ <sub>SPOT</sub>	↓	↓ <sub>SPOT</sub>	↓ <sub>SPOT</sub>		
1°	WELDING CURRENT	1	1	1	1	1	1	1	1	1	1	1	1	1	1
1°	MAX WELDING CURRENT	2	2		2	2		2	2		2	2		2	
1°	HOT-START	✓													
1°	ARC-FORCE	✓													
1°	PRE-GAS		3	3	3	3	3	3	3	3	3	3	3	3	3
1°	START CURRENT		✓	✓	✓	✓	✓	✓	✓	✓	✓	✓	✓	✓	✓
1°	SLOPE UP		4	4	4	4	4	4	4	4	4	4	4	4	4
1°	SECOND CURRENT BI-LEVEL			✓											✓
1°	BASE CURRENT				✓	✓	✓	✓	✓	✓	✓	✓	✓	✓	✓
1°	PEAK TIME				✓	✓	✓	✓	✓	✓	✓	✓	✓	✓	✓
1°	PULSE FREQUENCY				6	6	6	6	6	6	6	6	6	6	6
1°	BASE TIME				5	5	5	5	5	5	5	5	5	5	5
1°	SLOPE DOWN		4	4	4	4	4	4	4	4	4	4	4	4	4







## 11 WELDING SETTINGS

### 11.1 ELECTRODE WELDING (MMA)

- S5  This button serves to select the following welding mode:  MMA

#### 11.1.1 MMA PARAMETERS SETTING (1ST LEVEL)







- S3  Press this button to scroll the list of settings to edit.
-  The selected parameter and its value are shown on the following displays: D2
- E1  Using the encoder, edit the value of the selected setting.  
The value is saved automatically.
-  Press any key (except S3) to save the setting and quit the menu.

**Tab. 3 - Parameters of the 1st level menu in MMA mode**

PARAMETER	MIN	DEFAULT	MAX	
WELDING CURRENT	10 A	80 A	180 A	
HOT-START	0 %	50 %	100 %	*1
ARC-FORCE	0 %	30 %	100 %	*1

\*1: This parameter is set as a percentage referred to the value of the following parameter: WELDING CURRENT

#### 11.1.2 MMA PARAMETERS SETTING (2ND LEVEL)

- S3  Hold down the button for 3 seconds to gain access to the 2nd level menu.
-  **L.2** The message appears on the following displays: D1  
L.2= LEVEL.2= 2ND LEVEL MENU
-  The selected parameter and its value are shown on the following displays: D2
- S3  Press this button to scroll the list of settings to edit.
- E1  Using the encoder, edit the value of the selected setting.  
The value is saved automatically.
-  Press any key (except S3) to save the setting and quit the menu.

**Tab. 4 - Parameters of the 2nd level menu in MMA mode**

PARAMETER	MIN	DEFAULT	MAX	
VRD	OFF	OFF	ON	*3
LONG ARC VOLTAGE	37	SYN	65	*4
REMOTE CONTROL	OFF	OFF	ON	*2

\*2: The activation is suitable for the following welding modes:

- MMA
  - DC TIG
  - AC TIG
- Compatible remote control types:





- manual remote controller.

\*3: The activation is suitable for the following welding modes:

- MMA

\*4: SYN: This code indicates that parameters control is synergic. The optimal value of this parameter is set automatically by the microprocessor on the basis of the preset welding current value. This value can be displayed but it is not user-adjustable.

#### 11.1.3 MMA SPECIAL FUNCTIONS

- S1  Press this button to scroll the list of settings to edit.
-  The selected parameter and its value are shown on the following displays: D2
- E1  Using the encoder, edit the value of the selected setting.  
The value is saved automatically.
-  Press any key (except S1) to save the setting and quit the menu.

**Tab. 5 - Special functions in MMA mode**

PARAMETER	MIN	DEFAULT	MAX
DYNAMIC ARC	OFF	OFF	ON

**11.2 DC TIG WELDING**

S5 Use this button to select one of the following welding modes:

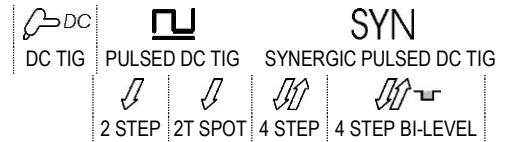

S4 Use this button to select one of the following torch trigger procedures:

**11.2.1 DC TIG PARAMETERS SETTING (1ST LEVEL)**

- S3 Press this button to scroll the list of settings to edit.
  - The selected parameter and its value are shown on the following displays: D2
- E1 Using the encoder, edit the value of the selected setting.
  - The value is saved automatically.
- Press any key (except S3) to save the setting and quit the menu.

**Tab. 6 - 1st level menu parameters in DC TIG mode**

PARAMETER	MIN	DEFAULT	MAX	
WELDING CURRENT	5 A	80 A	220 A	
MAX WELDING CURRENT	5 A	80 A	220 A	
SECOND CURRENT BI-LEVEL	10 %	50 %	200 %	*1
BASE CURRENT	1 %	40 %	200 %	
	SYN	SYN	SYN	*3
PEAK TIME	0.1 s	5.0 s	5.0 s	*5
	1 %	50 %	99 %	*4
	SYN	SYN	SYN	*3
BASE TIME	0.1 s	5.0 s	5.0 s	*5
	0.1 Hz	100 Hz	2.5 kHz	*4
PULSE FREQUENCY	0.1 Hz	5.0 Hz	5.0 Hz	*5
	SYN	SYN	SYN	*3
	SLOPE DOWN	0.0 s	0.0 s	25.0 s
FINAL CURRENT	5 %	5 %	80 %	*2
	5 A	5 A	220 A	*2
POST-GAS	0.0 s	10.0 s	25.0 s	
PRE-GAS	0.0 s	0.1 s	10.0 s	
START CURRENT	2 %	50 %	200 %	
	5 A	50 A	220 A	
SLOPE UP	0.0 s	0.0 s	25.0 s	

\*1: This parameter is set as a percentage referred to the value of the following parameter: WELDING CURRENT  
 \*2: The value of this parameter can be set as a percentage of the welding current or as an absolute value expressed in Amperes.  
 \*3: SYN: This code indicates that parameters control is synergic. The optimal value of this parameter is set automatically by the microprocessor on the basis of the preset welding current value. This value can be displayed but it is not user-adjustable.  
 \*4: Available when "KIND OF PULSE" parameter= FAST  
 \*5: Available when "KIND OF PULSE" parameter= SLOW

**11.2.2 DC TIG PARAMETERS SETTING (2ND LEVEL)**

- S3 Access the 2nd level menu by holding the button down for 3 seconds.
  - L.2** The message appears on the following displays: D1  
L.2= LEVEL.2= 2ND LEVEL MENU
- S3 Press this button to scroll the list of settings to edit.
  - The selected parameter and its value are shown on the following displays: D2
- E1 Using the encoder, edit the value of the selected setting.
  - The value is saved automatically.
- Press any key (except S3) to save the setting and quit the menu.

**Tab. 7 - 2nd level menu parameters in DC TIG mode**

PARAMETER	MIN	DEFAULT	MAX	
SPOT TIG TIME	0.01 s	0.1 s	10.0 s	
HF ARC START	ON	ON	OFF	
REMOTE CONTROL	OFF	OFF	ON	*1
MINIMUM PEDAL CURRENT	1 %	50 %	90 %	*2

\*1: The activation is suitable for the following welding modes:

- MMA
- DC TIG
- AC TIG

Compatible remote control types:

- manual remote controller.
- UP/DOWN or potentiometer TIG torch.
- foot pedal controller.

The maximum and minimum TIG welding current values can be set with the foot pedal controller.

The up slope and down slope cannot be controlled via the foot pedal.

The following welding procedures can be selected with the foot pedal:

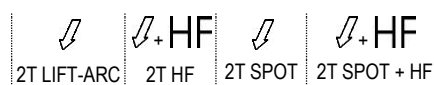

If both remote controllers are connected, the foot pedal assumes priority over the UP/DOWN or potentiometer TIG torch.

When this function is active welding is performed without the following parameters:

- SLOPE UP
- SLOPE DOWN
- All special functions

\*2: This parameter is set as a percentage referred to the value of the following parameter: WELDING CURRENT

### 11.2.3 DC TIG SPECIAL FUNCTIONS MENU

- S1 Press this button to scroll the list of settings to edit.
- The selected parameter and its value are shown on the following displays: D2
- E1 Using the encoder, edit the value of the selected setting.
- The value is saved automatically.
- Press any key (except S1) to save the setting and quit the menu.

**Tab. 8 - Special functions in DC TIG**

PARAMETER	MIN	DEFAULT	MAX	
DYNAMIC ARC	1 A	OFF	50 A	*3
Q-START	0.1 s	OFF	60.0 s	*3
MULTI-TACK	0.5 Hz	OFF	6.0 Hz	*2 *3

\*2: When this function is active welding is performed without the following parameters:

- SLOPE UP
- SLOPE DOWN
- START CURRENT
- FINAL CURRENT
- DYNAMIC ARC
- Q-START

\*3: When "REMOTE CONTROL"= ON and a foot pedal is connected the functions are all inhibited.

**11.3 AC TIG WELDING**





S5  Use this button to select one of the following welding modes:



S4  Use this button to select one of the following torch trigger procedures:



**11.3.1 AC TIG PARAMETERS SETTING (1ST LEVEL)**







- S3  Press this button to scroll the list of settings to edit.
  -  The selected parameter and its value are shown on the following displays: D2
- E1  Using the encoder, edit the value of the selected setting.  
The value is saved automatically.
-  Press any key (except S3) to save the setting and quit the menu.

**Tab. 9 - 1st level menu parameters in AC TIG mode**

PARAMETER	MIN	DEFAULT	MAX	
WELDING CURRENT	5 A	80 A	220 A	
MAX WELDING CURRENT	5 A	80 A	220 A	
SECOND CURRENT BI-LEVEL	10 %	50 %	200 %	*1
BASE CURRENT	1 %	40 %	200 %	
	SYN	SYN	SYN	*3
PEAK TIME	0.1 s	5.0 s	5.0 s	*5
	1 %	50 %	99 %	*4
BASE TIME	SYN	SYN	SYN	*3
	0.1 s	5.0 s	5.0 s	*5
PULSE FREQUENCY	0.1 Hz	100 Hz	1.0 kHz	*4
	0.1 Hz	5.0 Hz	5.0 Hz	*5
	SYN	SYN	SYN	*3
SLOPE DOWN	0.0 s	0.0 s	25.0 s	
FINAL CURRENT	5 %	5 %	80 %	*2
	5 A	5 A	220 A	*2
POST-GAS	0.0 s	10.0 s	25.0 s	
PRE-GAS	0.0 s	0.1 s	10.0 s	
START CURRENT	2 %	50 %	200 %	
	5 A	40 A	220 A	
SLOPE UP	0.0 s	0.0 s	25.0 s	

- \*1: This parameter is set as a percentage referred to the value of the following parameter: WELDING CURRENT
- \*2: The value of this parameter can be set as a percentage of the welding current or as an absolute value expressed in Amperes.
- \*3: SYN: This code indicates that parameters control is synergic. The optimal value of this parameter is set automatically by the microprocessor on the basis of the preset welding current value. This value can be displayed but it is not user-adjustable.
- \*4: Available when "KIND OF PULSE" parameter= FAST
- \*5: Available when "KIND OF PULSE" parameter= SLOW









**11.3.2 AC TIG PARAMETERS SETTING (2ND LEVEL)**

- S3  Access the 2nd level menu by holding the button down for 3 seconds.
  -  **L.2** The message appears on the following displays: D1  
L.2= LEVEL.2= 2ND LEVEL MENU
- S3  Press this button to scroll the list of settings to edit.
  -  The selected parameter and its value are shown on the following displays: D2
- E1  Using the encoder, edit the value of the selected setting.  
The value is saved automatically.
-  Press any key (except S3) to save the setting and quit the menu.

**Tab. 10 - 2nd level menu parameters in AC TIG mode**

PARAMETER	MIN	DEFAULT	MAX
SPOT TIG TIME	0.01 s	0.1 s	10.0 s
REMOTE CONTROL	OFF	OFF	ON *1
MINIMUM PEDAL CURRENT	1 %	50 %	90 % *2
HF ARC START	ON	ON	OFF

VALUE	DC+	WAVEFORM	DC-
1	sine		sine
2	rectangular		rectangular
3	triangular		triangular
4	sine		rectangular
5	rectangular		sine
6	sine		triangular
7	triangular		sine
8	rectangular		triangular
9	triangular		rectangular

\*1: The activation is suitable for the following welding modes:

- MMA
  - DC TIG
  - AC TIG
- Compatible remote control types:
- manual remote controller.
  - UP/DOWN or potentiometer TIG torch.
  - foot pedal controller.

The maximum and minimum TIG welding current values can be set with the foot pedal controller.

The up slope and down slope cannot be controlled via the foot pedal.

The following welding procedures can be selected with the foot pedal:

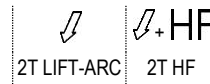



If both remote controllers are connected, the foot pedal assumes priority over the UP/DOWN or potentiometer TIG torch.

When this function is active welding is performed without the following parameters:

- SLOPE UP
- SLOPE DOWN

\*2: This parameter is set as a percentage referred to the value of the following parameter: WELDING CURRENT

**11.3.3 AC TIG SPECIAL FUNCTIONS MENU**

- S1  Press this button to scroll the list of settings to edit.
  -  The selected parameter and its value are shown on the following displays: D2
- E1  Using the encoder, edit the value of the selected setting.
 

The value is saved automatically.
-  Press any key (except S3) to save the setting and quit the menu.

**Tab. 11 - Special functions in AC TIG**

PARAMETER	MIN	DEFAULT	MAX
AC WAVE IN MIX AC-DC	10 %	OFF	80 %
EXTRA FUSION	1 %	OFF	80 %
AC FREQUENCY	20 Hz	65 Hz	200 Hz
AC BALANCE	-10	0	+10

## 12 JOBS MANAGEMENT

Personalised welding settings, or JOBS, can be saved in memory locations and subsequently uploaded.

Up to 50 jobs can be saved (j01-j50).

The settings of the SETUP menu are not saved.

### 12.1 SAVING A JOB

This function is available when welding mode is not active.

S5  Hold down the button for 3 seconds.

 **JOB STORAGE SELECTION** The message appears on the following displays: D2

S5  Press the button to confirm.

 **STORE JOB N.xx** The message appears on the following displays: D2

xx= number of the first free job.

 **JOB MEMORY FULL** When there are no free memory locations the message appears on the following displays: D2

E1  Use the encoder to select the required job number.

On selecting a currently occupied memory location, the job number flashes.

If you confirm at this point, the new job will overwrite the previously saved settings.

#### Exit without confirmation

 Press any button (except S2).

This action will automatically close the menu.

#### Exit with confirmation

S2  Press the button.

This action will automatically close the menu.

### 12.2 LOADING A USER JOB OF FACTORY SET JOB

This function is available when welding mode is not active.

S2  Press and release the button.

 **LOAD JOB N.xx** Only when the jobs have been uploaded, the message is shown on the following displays: D2

xx= number of the latest job used.

 **NO JOB LOADED** If there are no jobs in the memory the message is shown on the following displays: D2

E1  Use the encoder to select the number of the job to be uploaded.

#### Exit without confirmation

 Press any button (except S2).

This action will automatically close the menu.

#### Exit with confirmation

S2  Press the button.

 **LOADED JOB N.xx** The message appears on the following displays: D2

This action will automatically close the menu.

When a job is loaded and an UP/DOWN torch is installed, press the torch triggers to select the saved jobs.

### 12.3 DELETING A JOB

This function is available when welding mode is not active.

S2  Hold down the button for 3 seconds.

 **JOB STORAGE SELECTION** The message appears on the following displays: D2

E1  Select the following setting with the encoder:

 **JOB ERASURE SELECTION** The message appears only if there are saved JOBS, on the following displays: D2

S2  Press the button to confirm.

 **ERASE JOB N.xx** The message appears on the following displays: D2

xx= number of the latest job used.



**NO STORED JOB**

The message appears only if there are saved JOBS, on the following displays: D2

- E1  Use the encoder to select the number of the job to be deleted.

**Exit without confirmation**

-  Press any button (except S2).

This action will automatically close the menu.





**Exit with confirmation**

- S2  Press the button.





This action will automatically close the menu.

## 13 TORCH TRIGGER MODES





### 13.1 2T LIFT-ARC WELDING

1. Touch the workpiece with the torch electrode.
2. Press (1T) and keep the torch trigger pressed.
3. Slowly lift the torch to strike the arc.
  -  The welding current reaches the preset value, by way of a up slope time, if programmed.
4. Release (2T) the trigger to start the weld completion procedure.
  -  The current reaches the end current value in the time set in the down slope time parameter.
  -  The arc is extinguished.
  -  Gas delivery continues for the time set in the post gas parameter.

### 13.2 2T HF WELDING

1. Bring the torch up to the work until the electrode tip is approximately 2 or 3 mm away.
2. Press (1T) and keep the torch trigger pressed.
  -  The arc strikes without contact with the workpiece and the voltage discharges (HF) cease automatically.
  -  The welding current reaches the preset value, by way of a up slope time, if programmed.
3. Release (2T) the trigger to start the weld completion procedure.
  -  The current reaches the end current value in the time set in the down slope time parameter.
  -  The arc is extinguished.
  -  Gas delivery continues for the time set in the post gas parameter.

### 13.3 4T LIFT-ARC WELDING

1. Touch the workpiece with the torch electrode.
2. Press (1T) and release (2T) the torch trigger.
3. Slowly lift the torch to strike the arc.
  -  The welding current reaches the preset value, by way of a up slope time, if programmed.
4. Press (3T) the trigger and keep it pressed to start the weld completion procedure.
  -  The current reaches the end current value in the time set in the down slope time parameter.
  -  The arc continues and the current output will be the value set in the end current. parameter.
  -  In these conditions the weld pool can be closed (crater filler current).
5. Release (4T) the trigger to extinguish the arc.
  -  Gas delivery continues for the time set in the post gas parameter.

### 13.4 4T HF WELDING

1. Bring the torch up to the work until the electrode tip is approximately 2 or 3 mm away.
2. Press (1T) and release (2T) the torch trigger.
  - ➡ The arc strikes without contact with the workpiece and the voltage discharges (HF) cease automatically.
  - ➡ The welding current reaches the preset value, by way of a up slope time, if programmed.
3. Press (3T) the trigger and keep it pressed to start the weld completion procedure.
  - ➡ The current reaches the end current value in the time set in the down slope time parameter.
  - ➡ The arc continues and the current output will be the value set in the end current. parameter.
  - ⓘ In these conditions the weld pool can be closed (crater filler current).
4. Release (4T) the trigger to extinguish the arc.
  - ➡ Gas delivery continues for the time set in the post gas parameter.

### 13.5 BI-LEVEL LIFT WELDING

1. Touch the workpiece with the torch electrode.
2. Press (1T) and release (2T) the torch trigger.
3. Slowly lift the torch to strike the arc.
  - ➡ The welding current reaches the preset value, by way of a up slope time, if programmed.
4. Press and immediately release the torch trigger to switch to the second welding current.
  - ⓘ The trigger must not be pressed for more than 0.3 seconds; otherwise, the weld completion stage will start.
  - ⓘ When the trigger is pressed and released immediately, the system returns to the welding current.
5. Press (3T) the trigger and keep it pressed to start the weld completion procedure.
  - ➡ The current reaches the end current value in the time set in the down slope time parameter.
  - ➡ The arc continues and the current output will be the value set in the end current. parameter.
  - ⓘ In these conditions the weld pool can be closed (crater filler current).
6. Release (4T) the trigger to extinguish the arc.
  - ➡ Gas delivery continues for the time set in the post gas parameter.

### 13.6 BI-LEVEL HF WELDING

1. Bring the torch up to the work until the electrode tip is approximately 2 or 3 mm away.
2. Press (1T) and release (2T) the torch trigger.
  - ➡ The arc strikes without contact with the workpiece and the voltage discharges (HF) cease automatically.
  - ➡ The welding current reaches the preset value, by way of a up slope time, if programmed.
3. Press and immediately release the torch trigger to switch to the second welding current.
  - ⓘ The trigger must not be pressed for more than 0.3 seconds; otherwise, the weld completion stage will start.
  - ⓘ When the trigger is pressed and released immediately, the system returns to the welding current.
4. Press (3T) the trigger and keep it pressed to start the weld completion procedure.
  - ➡ The current reaches the end current value in the time set in the down slope time parameter.
  - ➡ The arc continues and the current output will be the value set in the end current. parameter.
  - ⓘ In these conditions the weld pool can be closed (crater filler current).
5. Release (4T) the trigger to extinguish the arc.
  - ➡ Gas delivery continues for the time set in the post gas parameter.

### 13.7 2T SPOT WELDING

1. Touch the workpiece with the torch electrode.
2. Press (1T) and keep the torch trigger pressed.
3. Slowly lift the torch to strike the arc.
4. Release (2T) the torch trigger.
  - ➡ The welding current reaches the preset value, by way of a up slope time, if programmed.
  - ➡ The welding procedure continues, at the preset current, for the time set with the spot time parameter.
  - ➡ The current reaches the end current value in the time set in the down slope time parameter.
  - ➡ The arc is extinguished.
  - ➡ Gas delivery continues for the time set in the post gas parameter.

### 13.8 2T SPOT HF WELDING

1. Bring the torch up to the work until the electrode tip is approximately 2 or 3 mm away.
2. Press (1T) the torch trigger.
  - ➡ The arc strikes without contact with the workpiece and the voltage discharges (HF) cease automatically.
3. Release (2T) the torch trigger.
  - ➡ The welding current reaches the preset value, by way of a up slope time, if programmed.
  - ➡ The welding procedure continues, at the preset current, for the time set with the spot time parameter.
  - ➡ The current reaches the end current value in the time set in the down slope time parameter.
  - ➡ The arc is extinguished.
  - ➡ Gas delivery continues for the time set in the post gas parameter.

#### Keep pressed torch trigger procedure

Bring the torch up to the work until the electrode tip is approximately 2 or 3 mm away.

Press (1T) the torch trigger.

- ➡ The arc strikes without contact with the workpiece and the voltage discharges (HF) cease automatically.
- ➡ The welding current reaches the preset value, by way of a up slope time, if programmed.
- ➡ The welding procedure continues, at the preset current, for the time set with the spot time parameter.
- ➡ The current reaches the end current value in the time set in the down slope time parameter.
- ➡ The arc is extinguished.
- ➡ Gas delivery continues for the time set in the post gas parameter.

Touch the workpiece with the torch electrode.

Slowly lift the torch to strike the arc.

### 13.9 PILOT ARC WELDING

The pilot arc can be activated in the following torch trigger procedures:

- 4T LIFT-ARC WELDING
- 4 TIMES + HF WELDING (4T HF)
- 4 TIMES BI-LEVEL + HF WELDING (4T BI-LEVEL HF)

The welding procedure with pilot arc differs with respect to the procedure without pilot arc in the part of the torch trigger procedure described below.

#### LIFT-ARC Welding

Touch the workpiece with the torch electrode.

Press (1T) and keep the torch trigger pressed.

Slowly lift the torch to strike the arc.

- ➡ The arc strikes, the welding current assumes the pilot current value.

Release (2T) the torch trigger.

- ➡ The welding current reaches the preset value, by way of a up slope time, if programmed.

etc.

#### Welding with HF

Press (1T) and keep the torch trigger pressed.

- ➡ The arc strikes without contact with the part and the voltage discharges (HF) cease automatically, the welding current will assume the pilot current value.



Release (2T) the torch trigger.

- ➡ The welding current reaches the preset value, by way of a up slope time, if programmed.

etc.

## 14 TECHNICAL DATA

Model	GLW 222 AC/DC
Construction standards	EN 60974-1 EN 60974-3 EN 60974-10 Class A
Supply voltage	1 x 230V $\pm$ 15 % / 50-60 Hz
Mains protection	25 A Delayed
Dimensions ( L x D x H )	460 x 230 x 325 mm
Weight	19 kg
Insulation class	H
Protection rating	IP23S
Cooling	AF
Maximum gas pressure	0,5 MPa (5 bar)
Z <sub>max</sub>	Compliant with EN 61000-3-12 Hook-up not dependent on the supply network

Temperature of the environment	40°C					
Welding mode	MMA			TIG		
Static characteristic						
Work cycle	40 %	60 %	100 %	35 %	60 %	100 %
Welding current	180 A	150 A	120 A	220 A	180 A	160 A
Working voltage	27.2 V	26.0 V	24.8 V	18.8 V	17.2 V	16.4 V
Maximum input power	6.2 KVA	4.7 KVA	3.6 KVA	5.4 KVA	4.2 KVA	3.6 KVA
Maximum supply current	30.0 A	22.3 A	16.3 A	25.7 A	20.2 A	16.3 A
Maximum effective supply current	18.9 A	17.2 A	16.3 A	15.2 A	15.6 A	16.3 A
No-load voltage (U <sub>0</sub> )	79 V			72 V		
Reduced no-load voltage (U <sub>r</sub> )	12 V					
Arc striking device designed to work with manual guided torch.						
Rated HF peak voltage						13.5 kV

## Spare parts list

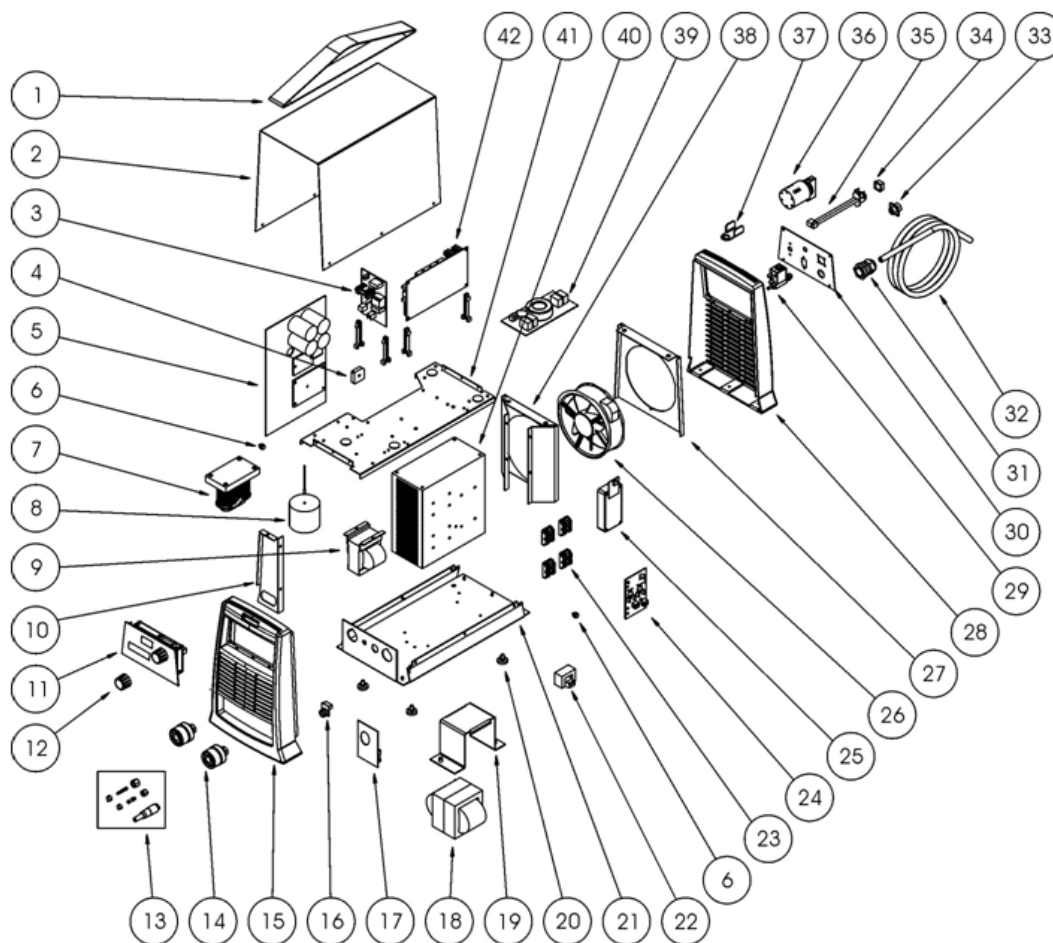

Item. Part No. Designation

1	0835 22 00 01	BELT
2	0835 22 00 02	UPPER COVER
3	0835 22 00 03	HF BOARD
4	0835 21 00 41	PRIMARY RECTIFIER
5	0835 21 00 03	POWER BOARD
6	0835 21 00 04	TERMAL SWITCH L=200mm
7	0835 21 00 05	HF TRANSFORMER
8	0835 22 00 04	BOOST INDUCTANCE
9	0835 22 00 05	OUTPUT INDUCTANCE
10	0835 21 00 07	LATERAL PLATE
11	0835 22 00 06	LOGIC FRONT PANEL
12	0835 21 00 10	KNOB
13	0835 21 00 12	KIT FOR GAS CONNECTORS
14	0835 21 00 11	FIXED SOCKETS 400A
15	0835 21 00 08	FRONT PLASTIC PANEL
16	0835 22 00 07	AMPHENOL CONN. BOARD
17	0835 21 00 14	OUTPUT FILTER BOARD
18	0835 21 00 16	POWER TRANSFORMER

Item.	Part No.	Designation
19	0835 21 00 17	TRANSFORMER SUPPORT
20	0835 22 00 08	RUBBER FOOT
21	0835 21 00 22	LOWER COVER
22	0835 21 00 18	HALL SENSOR
23	0535 22 00 09	DIODE
24	0835 22 00 10	SNUBBER BOARD
25	0835 22 00 11	INVERSION MODULE
26	0835 21 00 26	FAN
27	0835 21 00 27	EXTERNAL FAN SUPPORT
28	0835 21 00 28	REAR PLASTIC PANEL
29	0835 21 00 29	SOLENOID VALVE
30	0835 21 00 30	REAR PANEL
31	0835 21 00 31	CABLE CLAMP
32	0835 21 00 32	SUPPLY CABLE
33	0835 21 00 33	REMOTE CONTROL WIRING
34	0835 21 00 34	ILME CONNECTOR CAP
35	0835 21 00 35	CU 05 SUPPLY CABLE
36	0835 21 00 36	BI-POLE SWITCH
37	0835 21 00 37	SOLENOID VALVE PLATE
38	0835 22 00 12	INTERNAL FAN SUPPORT
39	0835 21 00 38	LINE FILTER BOARD
40	0835 21 00 20	HEAT SINK
41	0835 22 00 14	UPPER PLATE
42	0835 22 00 15	INVERSION BOARD

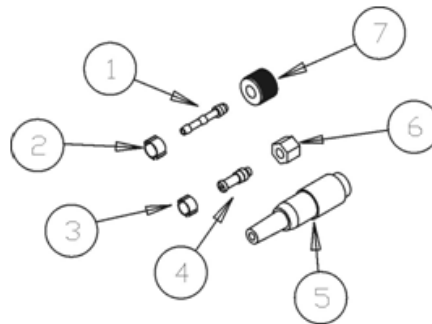

Item.	Part No.	Designation
1	0835 21 00 43	SLEEVE HOSE ADAPTER FOR RUBBER HOSE 1/4
2	0835 21 00 44	HOSE CLAMP Ø=11-13
3	0835 21 00 45	HOSE CLAMP Ø=07-09
4	0835 21 00 46	SLEEVE HOSE ADAPTER FOR RUBBER HOSE M10
5	0835 21 00 47	AMPHT3360-001 M/5V. VOL. CONNECTOR
6	0835 21 00 48	NUT M10
7	0835 21 00 49	NUT 1/4

### 14.2 Cooling unit FC 10

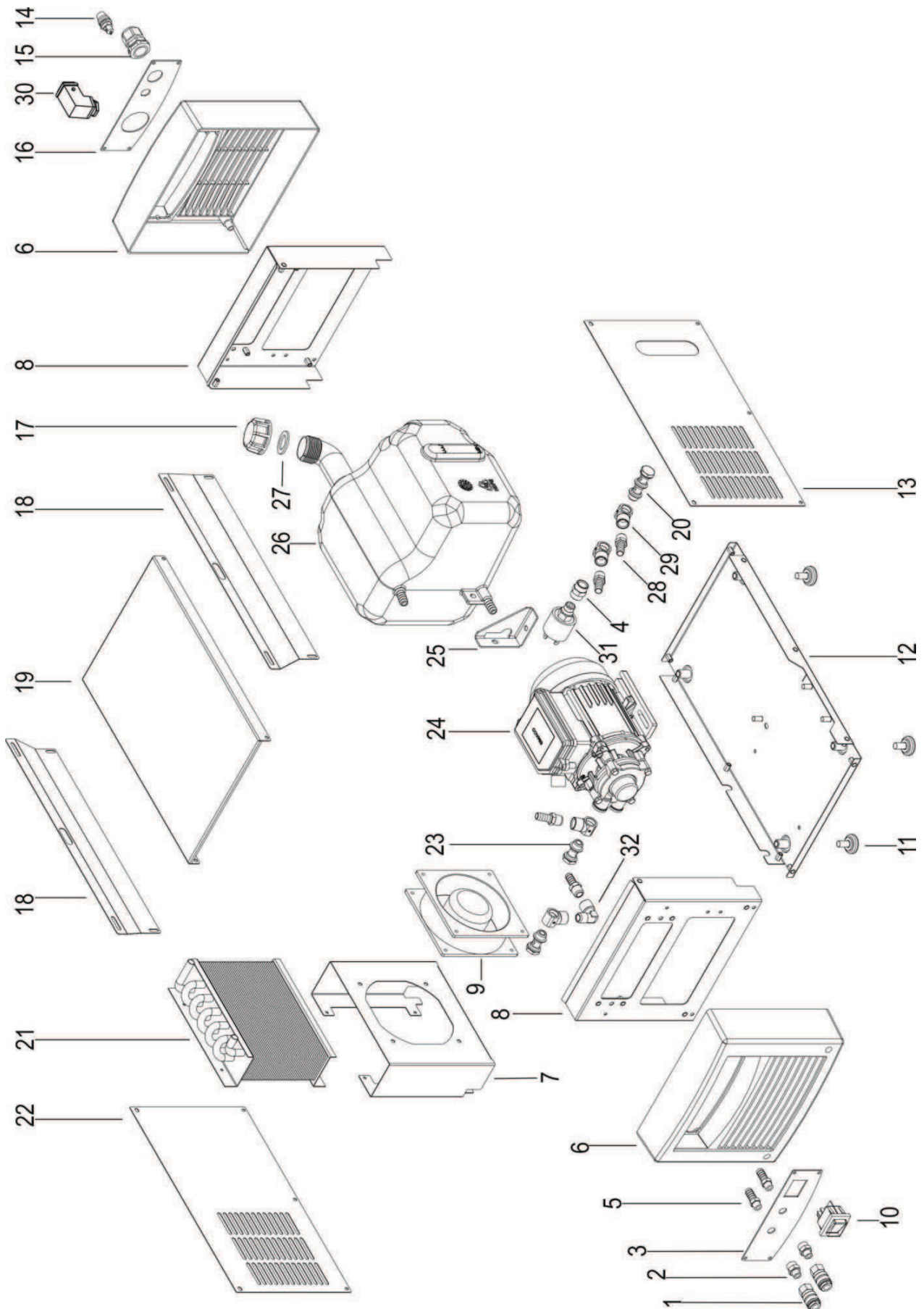

Pos. / Item	Artikelnummer / Part No.	Bezeichnung	Designation
1	0835 20 05 50	Schnellkupplung 1/8 Gas	QUICK CLUTCH 1/8 GAS
2	0835 20 05 51	Reduziernippel l=1/8 A=1/8	F=1/8 - M=1/8 NIPPLE CONNECTOR
3	0835 20 05 52	Frontblech	FRONT PLATE
4	0835 20 05 53	Reduziernippel l=1/4 A=1/4	F=1/4 - M=1/4 NIPPLE CONNECTOR
5	0835 20 05 54	Schlauchtülle 1/8 Ø10	SLEEVE HOSE ADAPTER FOR RUBBER HOSE Ø=10 mm F=1/8 M
6	0835 20 05 55	Lüftungsgitter	FRONT-REAR PLASTIC PANEL
7	0835 20 05 56	Halteblech Ventilator	RADIATOR SUPPORT
8	0835 20 05 57	Front-Rückwandblech	FRONT/REAR PLATE
9	0835 20 05 58	Ventilator	FAN
10	0835 20 05 59	Schalter	SWITCH
11	0835 20 05 60	Gummifuß	RUBBER FOOT
12	0835 20 05 61	Bodenblech	LOWER CASE
13	0835 20 05 62	Linke Seitenwand	LEFT SIDE COVER
14	0835 20 05 63	Sicherungshalter	FUSE HOLDER
15	0835 20 05 64	Kabelverschraubung	CABLE CLAMP
16	0835 20 05 65	Rückwandblech	REAR PLATE
17	0835 20 05 66	Tankverschluss	CAP
18	0835 20 05 67	Klemmblech	CLAMPING PLATE
19	0835 20 05 68	Deckelblech	UPPER COVER
20	0835 20 05 69	Hohlschraube 2-fach 1/4	DOUBLE HOLLOW BOLT M=1/4
21	0835 20 05 70	Kühler	RADIATOR
22	0835 20 05 71	Rechte Seitenwand	RIGHT SIDE COVER
23	0835 20 05 72	Hohlschraube 1-fach 1/4	HOLLOW BOLT M=1/4
24	0835 20 05 73	Pumpe	PUMP
25	0835 20 05 74	Befestigungswinkel Tank	TANK FIXING PLATE
26	0835 20 05 75	Tank	TANK
27	0835 20 05 76	Tankdichtung	GASKET
28	0835 20 05 77	Schlauchtülle 1/4 Ø10	SLEEVE HOSE ADAPTER FOR RUBBER HOSE d=10 mm F=1/4 M
29	0835 20 05 78	Ringschlauchstück 1/4	HYDRAULIC SWIVEL JOINT LF=1/4
30	0835 20 05 79	Anschlusskabel	POWER SUPPLY CABLE
31	0835 20 05 80	Druckschalter	PRESSURE SWITCH
32	0835 20 05 81	Winkelfitting 90° IG1/4 AG1/4	90° F=1/4 - M=1/4 NIPPLE CONNECTOR



**17 HILFSVORRICHTUNGEN**

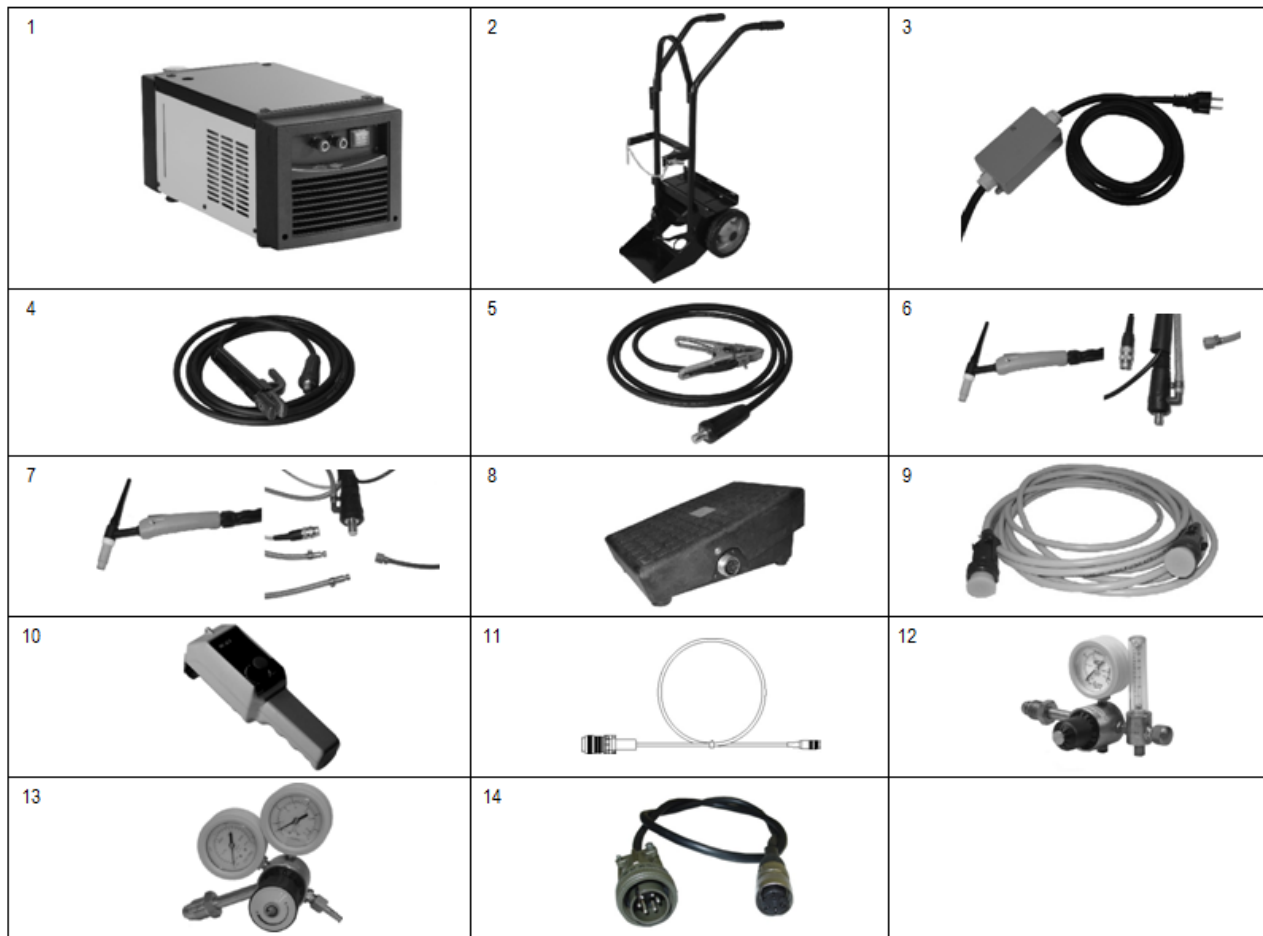

**Item. Part No. Designation**

1	0835 20 05 00	Cooling unit CU-05C
2	0835 20 01 00	Trolley 02
3	0835 20 04 00	Overcut (Generator protection)
4	0831 90 03 35	Electrode holder 35mm2 L=4m
5	0831 90 02 40	Earth cable 35mm2 L=4m
6	0875 13 04 00	TIG Torch SINTIG 26 L=4m AIR
	0875 33 04 00	TIG Torch SINTIG 26 RC (Potentiometer) L=4m AIR
7	0875 13 08 00	TIG Torch SINTIG 18 RC (Potentiometer) L=4m H2O
	0875 34 04 00	TIG Torch SINTIG 18 L=4m H2O
8	0835 20 02 00	Foot pedal RC02
9	0835 20 02 05	Extension cable for foot pedal L=5m
	0835 20 02 10	Extension cable for foot pedal L=10m
	0835 20 02 20	Extension cable for foot pedal L=20m
10	0835 20 03 00	Remote control RC03
11	0535 20 03 05	Extension cable for remote control L=5m
	0535 20 03 10	Extension cable for remote control L=10m
	0535 20 03 20	Extension cable for remote control L=20m

16.2 TORCH CONNECTOR

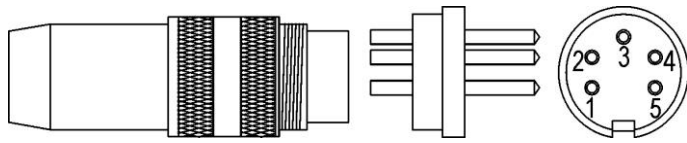

Torch

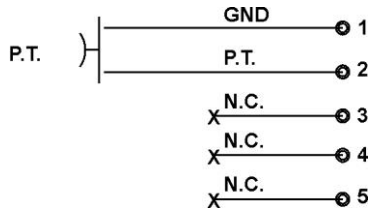

Up & down torch

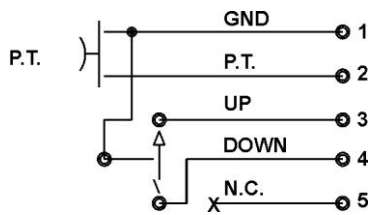

16.3 REMOTE CONTROLLER CONNECTOR

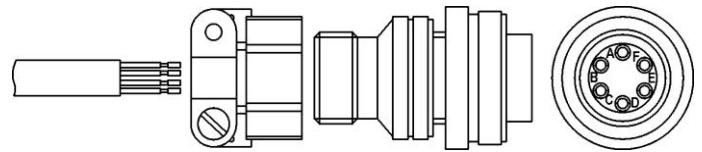

Torch with potentiometer

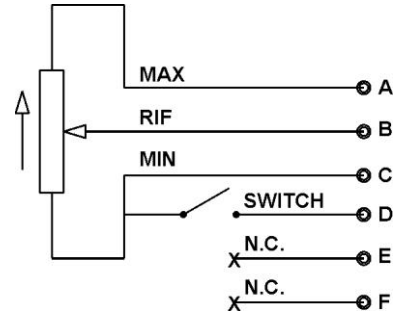

2 kOhm - 10 kOhm potentiometer

Remote controller

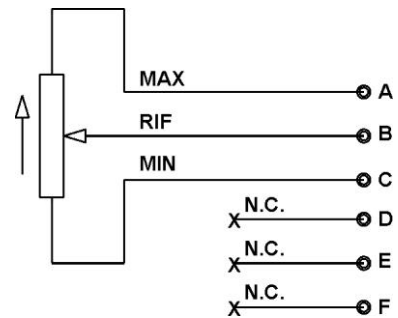

2 kOhm - 10 kOhm potentiometer

Foot pedal controller

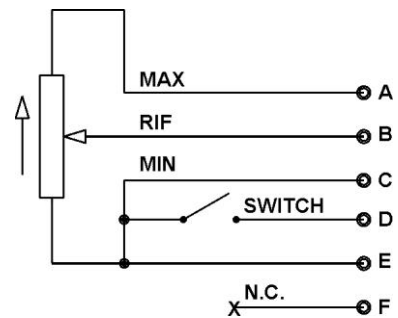

2 kOhm - 10 kOhm potentiometer

